

Test Booklet Code

No. :

AGAJHA

N4

This Booklet contains 28 pages.

Do not open this Test Booklet until you are asked to do so.

Important Instructions :

1. The Answer Sheet is inside this Test Booklet. When you are directed to open the Test Booklet, take out the Answer Sheet and fill in the particulars on OFFICE Copy carefully with **blue/black** ball point pen only.
2. The test is of **3 hours** duration and the Test Booklet contains **200** multiple-choice questions (four options with a single correct answer) from **Physics, Chemistry and Biology (Botany and Zoology)**. **50** questions in each subject are divided into **two Sections (A and B)** as per details given below :
 - (a) **Section A** shall consist of **35 (Thirty-five)** Questions in each subject (Question Nos – 1 to 35, 51 to 85, 101 to 135 and 151 to 185). All questions are compulsory.
 - (b) **Section B** shall consist of **15 (Fifteen)** questions in each subject (Question Nos – 36 to 50, 86 to 100, 136 to 150 and 186 to 200). In Section B, a candidate needs to **attempt any 10 (Ten)** questions out of **15 (Fifteen)** in each subject.

Candidates are advised to read all 15 questions in each subject of Section B before they start attempting the question paper. In the event of a candidate attempting more than ten questions, the first ten questions answered by the candidate shall be evaluated.
3. Each question carries **4** marks. For each correct response, the candidate will get **4** marks. For each incorrect response, **one** mark will be deducted from the total scores. **The maximum marks are 720.**
4. Use **Blue/Black Ball Point Pen only** for writing particulars on this page/markings responses on Answer Sheet.
5. Rough work is to be done in the space provided for this purpose in the Test Booklet only.
6. On completion of the test, the candidate **must hand over the Answer Sheet (ORIGINAL and OFFICE Copy) to the Invigilator** before leaving the Room/Hall. The candidates are allowed to take away this Test Booklet with them.
7. **The CODE for this Booklet is N4. Make sure that the CODE printed on the Original Copy of the Answer Sheet is the same as that on this Test Booklet.** In case of discrepancy, the candidate should immediately report the matter to the Invigilator for replacement of both the Test Booklet and the Answer Sheet.
8. The candidates should ensure that the Answer Sheet is not folded. Do not make any stray marks on the Answer Sheet. Do not write your Roll No. anywhere else except in the specified space in the Test Booklet/ Answer Sheet.
9. Use of white fluid for correction is **NOT** permissible on the Answer Sheet.
10. Each candidate must show on demand his/her Admit Card to the Invigilator.
11. No candidate, without special permission of the centre Superintendent or Invigilator, would leave his/her seat.
12. The candidates should not leave the Examination Hall without handing over their Answer Sheet to the Invigilator on duty and sign (with time) the Attendance Sheet **twice**. **Cases, where a candidate has not signed the Attendance Sheet second time, will be deemed not to have handed over the Answer Sheet and dealt with as an Unfair Means case.**
13. Use of Electronic/Manual Calculator is prohibited.
14. The candidates are governed by all Rules and Regulations of the examination with regard to their conduct in the Examination Room/Hall. All cases of unfair means will be dealt with as per the Rules and Regulations of this examination.
15. **No part of the Test Booklet and Answer Sheet shall be detached under any circumstances.**
16. The candidates will write the Correct Test Booklet Code as given in the Test Booklet/Answer Sheet in the Attendance Sheet.

Name of the Candidate (in Capitals) : _____

Roll Number : in figures _____

: in words _____

Centre of Examination (in Capitals) : _____

Candidate's Signature : _____ Invigilator's Signature : _____

Facsimile signature stamp of
Centre Superintendent : _____

Section - A (Physics)

1. A dipole is placed in an electric field as shown. In which direction will it move ?

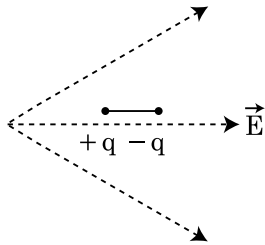

- (1) towards the right as its potential energy will decrease.
 (2) towards the left as its potential energy will decrease.
 (3) towards the right as its potential energy will increase.
 (4) towards the left as its potential energy will increase.

2. Consider the following **statements (A)** and **(B)** and identify the **correct** answer.

(A) A zener diode is connected in reverse bias, when used as a voltage regulator.

(B) The potential barrier of p-n junction lies between 0.1 V to 0.3 V.

- (1) **(A)** and **(B)** both are incorrect.
 (2) **(A)** is correct and **(B)** is incorrect.
 (3) **(A)** is incorrect but **(B)** is correct.
 (4) **(A)** and **(B)** both are correct.

3. In a potentiometer circuit a cell of EMF 1.5 V gives balance point at 36 cm length of wire. If another cell of EMF 2.5 V replaces the first cell, then at what length of the wire, the balance point occurs ?

- (1) 21.6 cm
 (2) 64 cm
 (3) 62 cm
 (4) 60 cm

4. Match **Column - I** and **Column - II** and choose the **correct** match from the given choices.

Column - I	Column - II
(A) Root mean square speed of gas molecules	(P) $\frac{1}{3}nm\bar{v}^2$
(B) Pressure exerted by ideal gas	(Q) $\sqrt{\frac{3RT}{M}}$
(C) Average kinetic energy of a molecule	(R) $\frac{5}{2}RT$
(D) Total internal energy of 1 mole of a diatomic gas	(S) $\frac{3}{2}k_B T$

- (1) (A) - (Q), (B) - (R), (C) - (S), (D) - (P)
 (2) (A) - (Q), (B) - (P), (C) - (S), (D) - (R)
 (3) (A) - (R), (B) - (Q), (C) - (P), (D) - (S)
 (4) (A) - (R), (B) - (P), (C) - (S), (D) - (Q)

5. The velocity of a small ball of mass M and density d, when dropped in a container filled with glycerine becomes constant after some time. If the density of glycerine is $\frac{d}{2}$, then the viscous force acting on the ball will be :

- (1) Mg
 (2) $\frac{3}{2}Mg$
 (3) 2Mg
 (4) $\frac{Mg}{2}$

6. An infinitely long straight conductor carries a current of 5 A as shown. An electron is moving with a speed of 10^5 m/s parallel to the conductor. The perpendicular distance between the electron and the conductor is 20 cm at an instant. Calculate the magnitude of the force experienced by the electron at that instant.

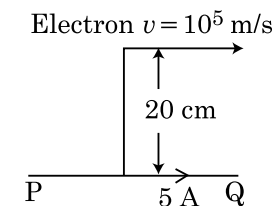

- (1) $8\pi \times 10^{-20}$ N
 (2) $4\pi \times 10^{-20}$ N
 (3) 8×10^{-20} N
 (4) 4×10^{-20} N

7. Polar molecules are the molecules :
- (1) acquire a dipole moment only in the presence of electric field due to displacement of charges.
 - (2) acquire a dipole moment only when magnetic field is absent.
 - (3) having a permanent electric dipole moment.
 - (4) having zero dipole moment.
8. A capacitor of capacitance 'C', is connected across an ac source of voltage V, given by
 $V = V_0 \sin \omega t$
 The displacement current between the plates of the capacitor, would then be given by :
- (1) $I_d = \frac{V_0}{\omega C} \cos \omega t$
 - (2) $I_d = \frac{V_0}{\omega C} \sin \omega t$
 - (3) $I_d = V_0 \omega C \sin \omega t$
 - (4) $I_d = V_0 \omega C \cos \omega t$
9. A lens of large focal length and large aperture is best suited as an objective of an astronomical telescope since :
- (1) a large aperture contributes to the quality and visibility of the images.
 - (2) a large area of the objective ensures better light gathering power.
 - (3) a large aperture provides a better resolution.
 - (4) all of the above.
10. A cup of coffee cools from 90°C to 80°C in t minutes, when the room temperature is 20°C . The time taken by a similar cup of coffee to cool from 80°C to 60°C at a room temperature same at 20°C is :
- (1) $\frac{13}{5}t$
 - (2) $\frac{10}{13}t$
 - (3) $\frac{5}{13}t$
 - (4) $\frac{13}{10}t$
11. A nucleus with mass number 240 breaks into two fragments each of mass number 120, the binding energy per nucleon of unfragmented nuclei is 7.6 MeV while that of fragments is 8.5 MeV. The total gain in the Binding Energy in the process is :
- (1) 9.4 MeV
 - (2) 804 MeV
 - (3) 216 MeV
 - (4) 0.9 MeV
12. A radioactive nucleus ${}^A_Z\text{X}$ undergoes spontaneous decay in the sequence
 ${}^A_Z\text{X} \rightarrow {}_{Z-1}\text{B} \rightarrow {}_{Z-3}\text{C} \rightarrow {}_{Z-2}\text{D}$, where Z is the atomic number of element X. The possible decay particles in the sequence are :
- (1) α, β^+, β^-
 - (2) β^+, α, β^-
 - (3) β^-, α, β^+
 - (4) α, β^-, β^+
13. The half-life of a radioactive nuclide is 100 hours. The fraction of original activity that will remain after 150 hours would be :
- (1) $\frac{1}{2\sqrt{2}}$
 - (2) $\frac{2}{3}$
 - (3) $\frac{2}{3\sqrt{2}}$
 - (4) $1/2$
14. If E and G respectively denote energy and gravitational constant, then $\frac{E}{G}$ has the dimensions of :
- (1) $[\text{M}] [\text{L}^{-1}] [\text{T}^{-1}]$
 - (2) $[\text{M}] [\text{L}^0] [\text{T}^0]$
 - (3) $[\text{M}^2] [\text{L}^{-2}] [\text{T}^{-1}]$
 - (4) $[\text{M}^2] [\text{L}^{-1}] [\text{T}^0]$
15. A spring is stretched by 5 cm by a force 10 N. The time period of the oscillations when a mass of 2 kg is suspended by it is :
- (1) 6.28 s
 - (2) 3.14 s
 - (3) 0.628 s
 - (4) 0.0628 s

16. Two charged spherical conductors of radius R_1 and R_2 are connected by a wire. Then the ratio of surface charge densities of the spheres (σ_1/σ_2) is :

- (1) $\frac{R_2}{R_1}$
 (2) $\sqrt{\left(\frac{R_1}{R_2}\right)}$
 (3) $\frac{R_1^2}{R_2^2}$
 (4) $\frac{R_1}{R_2}$

17. The electron concentration in an n-type semiconductor is the same as hole concentration in a p-type semiconductor. An external field (electric) is applied across each of them. Compare the currents in them.

- (1) current in p-type > current in n-type.
 (2) current in n-type > current in p-type.
 (3) No current will flow in p-type, current will only flow in n-type.
 (4) current in n-type = current in p-type.

18. A screw gauge gives the following readings when used to measure the diameter of a wire

Main scale reading : 0 mm

Circular scale reading : 52 divisions

Given that 1 mm on main scale corresponds to 100 divisions on the circular scale. The diameter of the wire from the above data is :

- (1) 0.026 cm
 (2) 0.26 cm
 (3) 0.052 cm
 (4) 0.52 cm

19. The equivalent capacitance of the combination shown in the figure is :

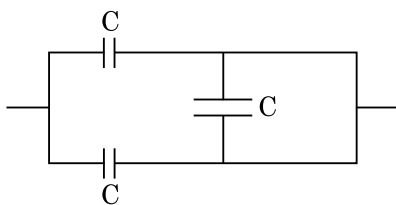

- (1) $2C$
 (2) $C/2$
 (3) $3C/2$
 (4) $3C$

20. The number of photons per second on an average emitted by the source of monochromatic light of wavelength 600 nm, when it delivers the power of 3.3×10^{-3} watt will be : ($h = 6.6 \times 10^{-34}$ Js)

- (1) 10^{17}
 (2) 10^{16}
 (3) 10^{15}
 (4) 10^{18}

21. A parallel plate capacitor has a uniform electric field ' \vec{E} ' in the space between the plates. If the distance between the plates is 'd' and the area of each plate is 'A', the energy stored in the capacitor is : (ϵ_0 = permittivity of free space)

- (1) $\epsilon_0 E A d$
 (2) $\frac{1}{2} \epsilon_0 E^2 A d$
 (3) $\frac{E^2 A d}{\epsilon_0}$
 (4) $\frac{1}{2} \epsilon_0 E^2$

22. A body is executing simple harmonic motion with frequency 'n', the frequency of its potential energy is :

- (1) $2n$
 (2) $3n$
 (3) $4n$
 (4) n

23. Find the value of the angle of emergence from the prism. Refractive index of the glass is $\sqrt{3}$.

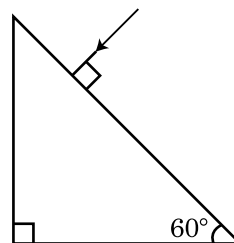

- (1) 30°
 (2) 45°
 (3) 90°
 (4) 60°

24. For a plane electromagnetic wave propagating in x -direction, which one of the following combination gives the correct possible directions for electric field (E) and magnetic field (B) respectively ?

- (1) $-\hat{j} + \hat{k}, -\hat{j} - \hat{k}$
 (2) $\hat{j} + \hat{k}, -\hat{j} - \hat{k}$
 (3) $-\hat{j} + \hat{k}, -\hat{j} + \hat{k}$
 (4) $\hat{j} + \hat{k}, \hat{j} + \hat{k}$

25. A convex lens 'A' of focal length 20 cm and a concave lens 'B' of focal length 5 cm are kept along the same axis with a distance 'd' between them. If a parallel beam of light falling on 'A' leaves 'B' as a parallel beam, then the distance 'd' in cm will be :

- (1) 15
 (2) 50
 (3) 30
 (4) 25

26. A small block slides down on a smooth inclined plane, starting from rest at time $t=0$. Let S_n be the distance travelled by the block in the interval $t=n-1$ to $t=n$. Then, the ratio $\frac{S_n}{S_{n+1}}$ is :

- (1) $\frac{2n-1}{2n+1}$
 (2) $\frac{2n+1}{2n-1}$
 (3) $\frac{2n}{2n-1}$
 (4) $\frac{2n-1}{2n}$

27. An inductor of inductance L , a capacitor of capacitance C and a resistor of resistance 'R' are connected in series to an ac source of potential difference 'V' volts as shown in figure. Potential difference across L , C and R is 40 V, 10 V and 40 V, respectively. The amplitude of current flowing through LCR series circuit is $10\sqrt{2}$ A. The impedance of the circuit is :

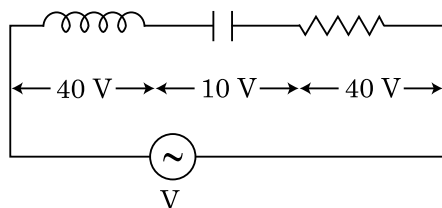

- (1) $5/\sqrt{2} \Omega$
 (2) 4Ω
 (3) 5Ω
 (4) $4\sqrt{2} \Omega$

28. If force [F], acceleration [A] and time [T] are chosen as the fundamental physical quantities. Find the dimensions of energy.

- (1) [F] [A] [T²]
 (2) [F] [A] [T⁻¹]
 (3) [F] [A⁻¹] [T]
 (4) [F] [A] [T]

29. **Column - I** gives certain physical terms associated with flow of current through a metallic conductor. **Column - II** gives some mathematical relations involving electrical quantities. Match **Column - I** and **Column - II** with appropriate relations.

Column - I	Column - II
(A) Drift Velocity	(P) $\frac{m}{ne^2 \rho}$
(B) Electrical Resistivity	(Q) nev_d
(C) Relaxation Period	(R) $\frac{eE}{m} \tau$
(D) Current Density	(S) $\frac{E}{J}$
(1) (A)-(R), (B)-(S), (C)-(Q), (D)-(P)	
(2) (A)-(R), (B)-(P), (C)-(S), (D)-(Q)	
(3) (A)-(R), (B)-(Q), (C)-(S), (D)-(P)	
(4) (A)-(R), (B)-(S), (C)-(P), (D)-(Q)	

30. The escape velocity from the Earth's surface is v . The escape velocity from the surface of another planet having a radius, four times that of Earth and same mass density is :

- (1) $2v$
 (2) $3v$
 (3) $4v$
 (4) v

31. An electromagnetic wave of wavelength ' λ ' is incident on a photosensitive surface of negligible work function. If ' m ' mass is of photoelectron emitted from the surface has de-Broglie wavelength λ_d , then :

(1) $\lambda_d = \left(\frac{2mc}{h}\right)\lambda^2$

(2) $\lambda = \left(\frac{2mc}{h}\right)\lambda_d^2$

(3) $\lambda = \left(\frac{2h}{mc}\right)\lambda_d^2$

(4) $\lambda = \left(\frac{2m}{hc}\right)\lambda_d^2$

32. The effective resistance of a parallel connection that consists of four wires of equal length, equal area of cross-section and same material is 0.25Ω . What will be the effective resistance if they are connected in series ?

- (1) 0.5Ω
 (2) 1Ω
 (3) 4Ω
 (4) 0.25Ω

33. A particle is released from height S from the surface of the Earth. At a certain height its kinetic energy is three times its potential energy. The height from the surface of earth and the speed of the particle at that instant are respectively :

(1) $\frac{S}{4}, \frac{\sqrt{3gS}}{2}$

(2) $\frac{S}{2}, \frac{\sqrt{3gS}}{2}$

(3) $\frac{S}{4}, \sqrt{\frac{3gS}{2}}$

(4) $\frac{S}{4}, \frac{3gS}{2}$

34. Water falls from a height of 60 m at the rate of 15 kg/s to operate a turbine. The losses due to frictional force are 10% of the input energy. How much power is generated by the turbine ?

($g = 10 \text{ m/s}^2$)

- (1) 8.1 kW
 (2) 12.3 kW
 (3) 7.0 kW
 (4) 10.2 kW

35. A thick current carrying cable of radius ' R ' carries current ' I ' uniformly distributed across its cross-section. The variation of magnetic field $B(r)$ due to the cable with the distance ' r ' from the axis of the cable is represented by :

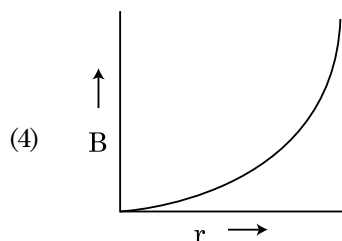
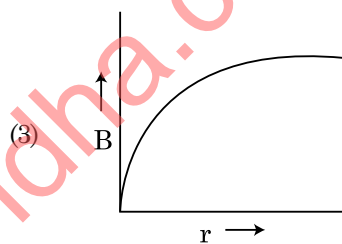
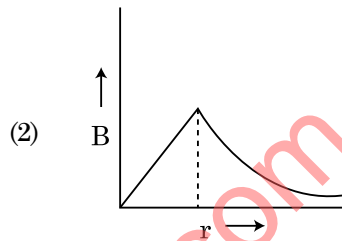
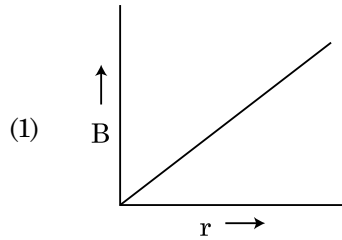

Section - B (Physics)

36. A uniform conducting wire of length $12a$ and resistance ' R ' is wound up as a current carrying coil in the shape of,

- (i) an equilateral triangle of side ' a '.
 (ii) a square of side ' a '.

The magnetic dipole moments of the coil in each case respectively are :

- (1) $3 Ia^2$ and Ia^2
 (2) $3 Ia^2$ and $4 Ia^2$
 (3) $4 Ia^2$ and $3 Ia^2$
 (4) $\sqrt{3} Ia^2$ and $3 Ia^2$

37. A step down transformer connected to an ac mains supply of 220 V is made to operate at 11 V, 44 W lamp. Ignoring power losses in the transformer, what is the current in the primary circuit ?

- (1) 0.4 A
- (2) 2 A
- (3) 4 A
- (4) 0.2 A

38. A uniform rod of length 200 cm and mass 500 g is balanced on a wedge placed at 40 cm mark. A mass of 2 kg is suspended from the rod at 20 cm and another unknown mass 'm' is suspended from the rod at 160 cm mark as shown in the figure. Find the value of 'm' such that the rod is in equilibrium. ($g = 10 \text{ m/s}^2$)

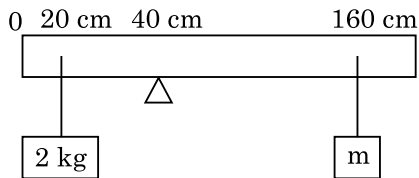

- (1) $\frac{1}{3}$ kg
- (2) $\frac{1}{6}$ kg
- (3) $\frac{1}{12}$ kg
- (4) $\frac{1}{2}$ kg

39. A point object is placed at a distance of 60 cm from a convex lens of focal length 30 cm. If a plane mirror were put perpendicular to the principal axis of the lens and at a distance of 40 cm from it, the final image would be formed at a distance of :

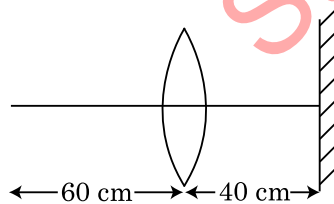

- (1) 30 cm from the lens, it would be a real image.
- (2) 30 cm from the plane mirror, it would be a virtual image.
- (3) 20 cm from the plane mirror, it would be a virtual image.
- (4) 20 cm from the lens, it would be a real image.

40. A particle of mass 'm' is projected with a velocity $v = kV_e$ ($k < 1$) from the surface of the earth.

($V_e = \text{escape velocity}$)

The maximum height above the surface reached by the particle is :

- (1) $R \left(\frac{k}{1+k} \right)^2$
- (2) $\frac{R^2 k}{1+k}$
- (3) $\frac{Rk^2}{1-k^2}$
- (4) $R \left(\frac{k}{1-k} \right)^2$

41. A ball of mass 0.15 kg is dropped from a height 10 m, strikes the ground and rebounds to the same height. The magnitude of impulse imparted to the ball is ($g = 10 \text{ m/s}^2$) nearly :

- (1) 4.2 kg m/s
- (2) 2.1 kg m/s
- (3) 1.4 kg m/s
- (4) 0 kg m/s

42. Twenty seven drops of same size are charged at 220 V each. They combine to form a bigger drop. Calculate the potential of the bigger drop.

- (1) 1320 V
- (2) 1520 V
- (3) 1980 V
- (4) 660 V

43. Two conducting circular loops of radii R_1 and R_2 are placed in the same plane with their centres coinciding. If $R_1 \gg R_2$, the mutual inductance M between them will be directly proportional to :

- (1) $\frac{R_2}{R_1}$
- (2) $\frac{R_1^2}{R_2}$
- (3) $\frac{R_2^2}{R_1}$
- (4) $\frac{R_1}{R_2}$

44. A series LCR circuit containing 5.0 H inductor, 80 μ F capacitor and 40 Ω resistor is connected to 230 V variable frequency ac source. The angular frequencies of the source at which power transferred to the circuit is half the power at the resonant angular frequency are likely to be :

- (1) 50 rad/s and 25 rad/s
- (2) 46 rad/s and 54 rad/s
- (3) 42 rad/s and 58 rad/s
- (4) 25 rad/s and 75 rad/s

45. Three resistors having resistances r_1 , r_2 and r_3 are connected as shown in the given circuit. The ratio $\frac{i_3}{i_1}$ of currents in terms of resistances used in the circuit is :

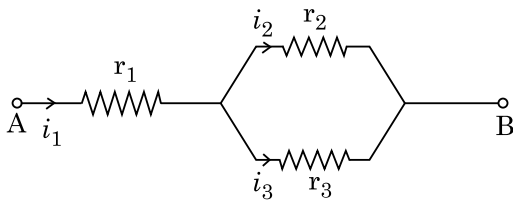

- (1) $\frac{r_2}{r_2 + r_3}$
- (2) $\frac{r_1}{r_1 + r_2}$
- (3) $\frac{r_2}{r_1 + r_3}$
- (4) $\frac{r_1}{r_2 + r_3}$

46. A car starts from rest and accelerates at 5 m/s^2 . At $t = 4$ s, a ball is dropped out of a window by a person sitting in the car. What is the velocity and acceleration of the ball at $t = 6$ s ? (Take $g = 10$ m/s^2)

- (1) 20 m/s, 0
- (2) $20\sqrt{2}$ m/s, 0
- (3) $20\sqrt{2}$ m/s, 10 m/s^2
- (4) 20 m/s, 5 m/s^2

47. In the product

$$\vec{F} = q \left(\vec{v} \times \vec{B} \right)$$

$$= q \vec{v} \times \left(B \hat{i} + B \hat{j} + B_0 \hat{k} \right)$$

For $q = 1$ and $\vec{v} = 2 \hat{i} + 4 \hat{j} + 6 \hat{k}$ and

$$\vec{F} = 4 \hat{i} - 20 \hat{j} + 12 \hat{k}$$

What will be the complete expression for \vec{B} ?

- (1) $-6 \hat{i} - 6 \hat{j} - 8 \hat{k}$
- (2) $8 \hat{i} + 8 \hat{j} - 6 \hat{k}$
- (3) $6 \hat{i} + 6 \hat{j} - 8 \hat{k}$
- (4) $-8 \hat{i} - 8 \hat{j} - 6 \hat{k}$

48. From a circular ring of mass 'M' and radius 'R' an arc corresponding to a 90° sector is removed. The moment of inertia of the remaining part of the ring about an axis passing through the centre of the ring and perpendicular to the plane of the ring is 'K' times MR^2 . Then the value of 'K' is :

- (1) $\frac{7}{8}$
- (2) $\frac{1}{4}$
- (3) $\frac{1}{8}$
- (4) $\frac{3}{4}$

49. A particle moving in a circle of radius R with a uniform speed takes a time T to complete one revolution.

If this particle were projected with the same speed at an angle ' θ ' to the horizontal, the maximum height attained by it equals 4R. The angle of projection, θ , is then given by :

- (1) $\theta = \cos^{-1} \left(\frac{\pi^2 R}{gT^2} \right)^{1/2}$
- (2) $\theta = \sin^{-1} \left(\frac{\pi^2 R}{gT^2} \right)^{1/2}$
- (3) $\theta = \sin^{-1} \left(\frac{2gT^2}{\pi^2 R} \right)^{1/2}$
- (4) $\theta = \cos^{-1} \left(\frac{gT^2}{\pi^2 R} \right)^{1/2}$

50. For the given circuit, the input digital signals are applied at the terminals A, B and C. What would be the output at the terminal y?

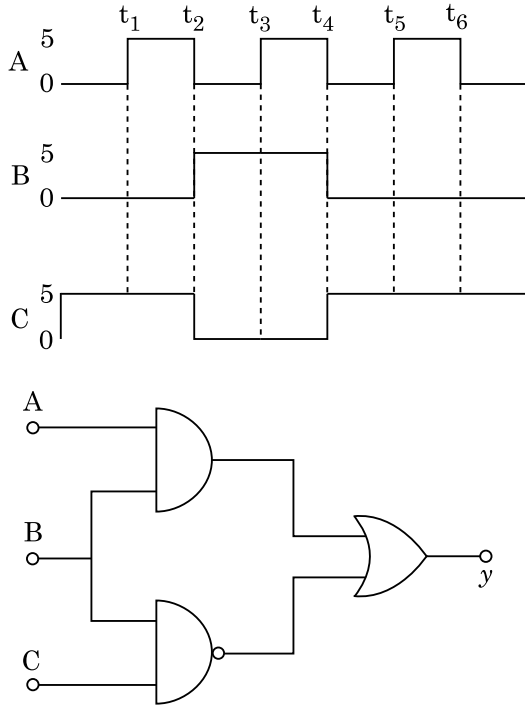

- (1) 0 V
- (2) 5 V
0 V
- (3) 5 V
- (4) 5 V
0 V

Section - A (Chemistry)

51. Choose the correct option for graphical representation of Boyle's law, which shows a graph of pressure vs. volume of a gas at different temperatures:

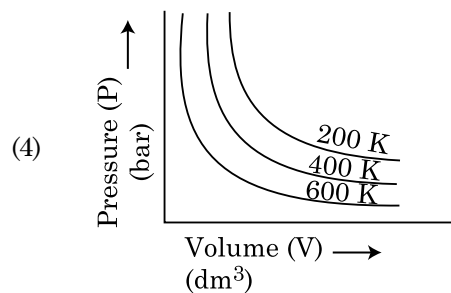
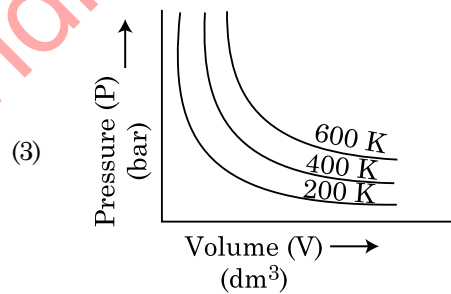
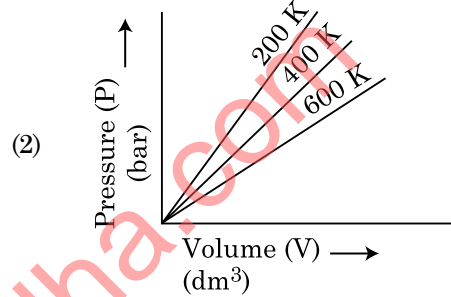
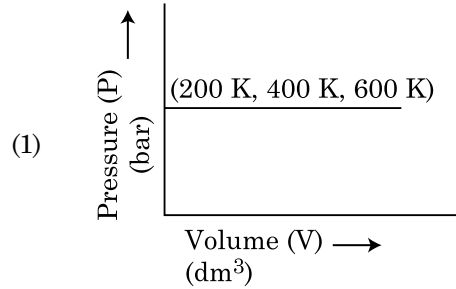

52. The molar conductance of NaCl, HCl and CH_3COONa at infinite dilution are 126.45, 426.16 and $91.0 \text{ S cm}^2 \text{ mol}^{-1}$ respectively. The molar conductance of CH_3COOH at infinite dilution is. Choose the right option for your answer.

- (1) $390.71 \text{ S cm}^2 \text{ mol}^{-1}$
 (2) $698.28 \text{ S cm}^2 \text{ mol}^{-1}$
 (3) $540.48 \text{ S cm}^2 \text{ mol}^{-1}$
 (4) $201.28 \text{ S cm}^2 \text{ mol}^{-1}$

53. Ethylene diaminetetraacetate (EDTA) ion is :
- (1) Unidentate ligand
 - (2) Bidentate ligand with two "N" donor atoms
 - (3) Tridentate ligand with three "N" donor atoms
 - (4) Hexadentate ligand with four "O" and two "N" donor atoms

54. The RBC deficiency is deficiency disease of :

- (1) Vitamin B₆
- (2) Vitamin B₁
- (3) Vitamin B₂
- (4) Vitamin B₁₂

55. BF₃ is planar and electron deficient compound. Hybridization and number of electrons around the central atom, respectively are :

- (1) sp³ and 6
- (2) sp² and 6
- (3) sp² and 8
- (4) sp³ and 4

56. The correct structure of 2,6-Dimethyl-dec-4-ene is :

- (1)
- (2)
- (3)
- (4)

57. The **incorrect** statement among the following is :

- (1) Most of the trivalent Lanthanoid ions are colorless in the solid state.
- (2) Lanthanoids are good conductors of heat and electricity.
- (3) Actinoids are highly reactive metals, especially when finely divided.
- (4) Actinoid contraction is greater for element to element than Lanthanoid contraction.

58. Tritium, a radioactive isotope of hydrogen, emits which of the following particles ?

- (1) Alpha (α)
- (2) Gamma (γ)
- (3) Neutron (n)
- (4) Beta (β^-)

59. For a reaction A \rightarrow B, enthalpy of reaction is -4.2 kJ mol^{-1} and enthalpy of activation is 9.6 kJ mol^{-1} . The correct potential energy profile for the reaction is shown in option.

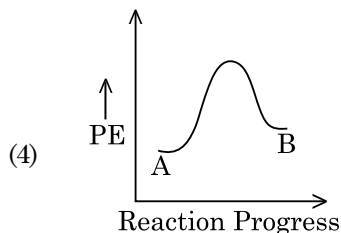
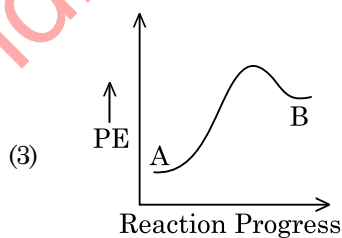
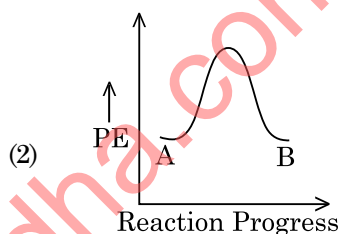
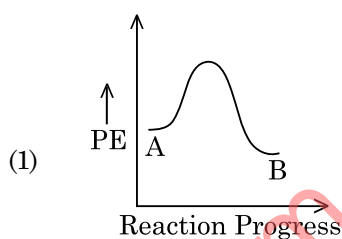

60. Right option for the number of tetrahedral and octahedral voids in hexagonal primitive unit cell are :

- (1) 6, 12
- (2) 2, 1
- (3) 12, 6
- (4) 8, 4

61. The compound which shows metamerism is :

- (1) C₃H₈O
- (2) C₃H₆O
- (3) C₄H₁₀O
- (4) C₅H₁₂

62. What is the IUPAC name of the organic compound formed in the following chemical reaction ?

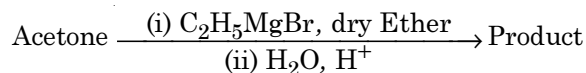

- (1) pentan-2-ol
 (2) pentan-3-ol
 (3) 2-methyl butan-2-ol
 (4) 2-methyl propan-2-ol
63. Which one of the following polymers is prepared by addition polymerisation ?
- (1) Nylon-66
 (2) Novolac
 (3) Dacron
 (4) Teflon

64. Match List - I with List - II.

List - I	List - II
(a) PCl_5	(i) Square pyramidal
(b) SF_6	(ii) Trigonal planar
(c) BrF_5	(iii) Octahedral
(d) BF_3	(iv) Trigonal bipyramidal

Choose the **correct** answer from the options given below.

- (1) (a)-(ii), (b)-(iii), (c)-(iv), (d)-(i)
 (2) (a)-(iii), (b)-(i), (c)-(iv), (d)-(ii)
 (3) (a)-(iv), (b)-(iii), (c)-(ii), (d)-(i)
 (4) (a)-(iv), (b)-(iii), (c)-(i), (d)-(ii)
65. The pK_b of dimethylamine and pK_a of acetic acid are 3.27 and 4.77 respectively at T (K). The correct option for the pH of dimethylammonium acetate solution is :
- (1) 5.50
 (2) 7.75
 (3) 6.25
 (4) 8.50

66. Given below are two statements :

Statement I :

Aspirin and Paracetamol belong to the class of narcotic analgesics.

Statement II :

Morphine and Heroin are non-narcotic analgesics.

In the light of the above statements, choose the **correct** answer from the options given below.

- (1) Both **Statement I** and **Statement II** are false.
 (2) **Statement I** is correct but **Statement II** is false.
 (3) **Statement I** is incorrect but **Statement II** is true.
 (4) Both **Statement I** and **Statement II** are true.
67. Dihedral angle of least stable conformer of ethane is :
- (1) 180°
 (2) 60°
 (3) 0°
 (4) 120°

68. Which one among the following is the correct option for right relationship between C_P and C_V for one mole of ideal gas ?

- (1) $C_P - C_V = R$
 (2) $C_P = RC_V$
 (3) $C_V = RC_P$
 (4) $C_P + C_V = R$

69. The following solutions were prepared by dissolving 10 g of glucose ($\text{C}_6\text{H}_{12}\text{O}_6$) in 250 ml of water (P_1), 10 g of urea ($\text{CH}_4\text{N}_2\text{O}$) in 250 ml of water (P_2) and 10 g of sucrose ($\text{C}_{12}\text{H}_{22}\text{O}_{11}$) in 250 ml of water (P_3). The right option for the decreasing order of osmotic pressure of these solutions is :

- (1) $P_1 > P_2 > P_3$
 (2) $P_2 > P_3 > P_1$
 (3) $P_3 > P_1 > P_2$
 (4) $P_2 > P_1 > P_3$

70. The correct option for the number of body centred unit cells in all 14 types of Bravais lattice unit cells is :

- (1) 5
 (2) 2
 (3) 3
 (4) 7

71. Zr (Z = 40) and Hf (Z = 72) have similar atomic and ionic radii because of :

- (1) diagonal relationship
- (2) lanthanoid contraction
- (3) having similar chemical properties
- (4) belonging to same group

72. Which one of the following methods can be used to obtain highly pure metal which is liquid at room temperature ?

- (1) Chromatography
- (2) Distillation
- (3) Zone refining
- (4) Electrolysis

73. Identify the compound that will react with Hinsberg's reagent to give a solid which dissolves in alkali.

- (1) $\text{CH}_3-\text{CH}_2-\ddot{\text{N}}\text{H}-\text{CH}_3$
- (2) $\text{CH}_3-\text{CH}_2-\ddot{\text{N}}\text{H}_2$
- (3) $\text{CH}_3-\text{CH}_2-\ddot{\text{N}}(\text{CH}_3)-\text{CH}_2-\text{CH}_3$
- (4) $\text{CH}_3-\text{CH}_2-\ddot{\text{N}}\text{O}_2$

74. The major product of the following chemical reaction is :

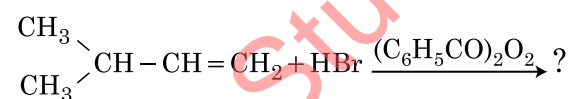

- (1) $\begin{array}{l} \text{CH}_3 \\ \diagdown \\ \text{CH} - \text{CH}_2 - \text{CH}_2 - \text{O} - \text{COC}_6\text{H}_5 \\ \diagup \\ \text{CH}_3 \end{array}$
- (2) $\begin{array}{l} \text{CH}_3 \\ \diagdown \\ \text{CH} - \text{CH} - \text{CH}_3 \\ \diagup \quad | \\ \text{CH}_3 \quad \text{Br} \end{array}$
- (3) $\begin{array}{l} \text{CH}_3 \\ \diagdown \\ \text{CBr} - \text{CH}_2 - \text{CH}_3 \\ \diagup \\ \text{CH}_3 \end{array}$
- (4) $\begin{array}{l} \text{CH}_3 \\ \diagdown \\ \text{CH} - \text{CH}_2 - \text{CH}_2 - \text{Br} \\ \diagup \\ \text{CH}_3 \end{array}$

75. The right option for the statement "Tyndall effect is exhibited by", is :

- (1) Glucose solution
- (2) Starch solution
- (3) Urea solution
- (4) NaCl solution

76. Noble gases are named because of their inertness towards reactivity. Identify an **incorrect** statement about them.

- (1) Noble gases have very high melting and boiling points.
- (2) Noble gases have weak dispersion forces.
- (3) Noble gases have large positive values of electron gain enthalpy.
- (4) Noble gases are sparingly soluble in water.

77. The correct sequence of bond enthalpy of 'C-X' bond is :

- (1) $\text{CH}_3 - \text{F} > \text{CH}_3 - \text{Cl} > \text{CH}_3 - \text{Br} > \text{CH}_3 - \text{I}$
- (2) $\text{CH}_3 - \text{F} < \text{CH}_3 - \text{Cl} > \text{CH}_3 - \text{Br} > \text{CH}_3 - \text{I}$
- (3) $\text{CH}_3 - \text{Cl} > \text{CH}_3 - \text{F} > \text{CH}_3 - \text{Br} > \text{CH}_3 - \text{I}$
- (4) $\text{CH}_3 - \text{F} < \text{CH}_3 - \text{Cl} < \text{CH}_3 - \text{Br} < \text{CH}_3 - \text{I}$

78. The major product formed in dehydrohalogenation reaction of 2-Bromo pentane is Pent-2-ene. This product formation is based on ?

- (1) Hund's Rule
- (2) Hofmann Rule
- (3) Huckel's Rule
- (4) Saytzeff's Rule

79. Which of the following reactions is the metal displacement reaction ? Choose the right option.

- (1) $\text{Cr}_2\text{O}_3 + 2\text{Al} \xrightarrow{\Delta} \text{Al}_2\text{O}_3 + 2\text{Cr}$
- (2) $\text{Fe} + 2\text{HCl} \rightarrow \text{FeCl}_2 + \text{H}_2 \uparrow$
- (3) $2\text{Pb}(\text{NO}_3)_2 \rightarrow 2\text{PbO} + 4\text{NO}_2 + \text{O}_2 \uparrow$
- (4) $2\text{KClO}_3 \xrightarrow{\Delta} 2\text{KCl} + 3\text{O}_2$

80. The structures of beryllium chloride in solid state and vapour phase, are :

- (1) Linear in both
- (2) Dimer and Linear, respectively
- (3) Chain in both
- (4) Chain and dimer, respectively

81. Among the following alkaline earth metal halides, one which is covalent and soluble in organic solvents is :

- (1) Strontium chloride
- (2) Magnesium chloride
- (3) Beryllium chloride
- (4) Calcium chloride

82. **Statement I :**

Acid strength increases in the order given as $\text{HF} \ll \text{HCl} \ll \text{HBr} \ll \text{HI}$.

Statement II :

As the size of the elements F, Cl, Br, I increases down the group, the bond strength of HF, HCl, HBr and HI decreases and so the acid strength increases.

In the light of the above statements, choose the **correct** answer from the options given below.

- (1) Both **Statement I** and **Statement II** are false.
- (2) **Statement I** is correct but **Statement II** is false.
- (3) **Statement I** is incorrect but **Statement II** is true.
- (4) Both **Statement I** and **Statement II** are true.

83. An organic compound contains 78% (by wt.) carbon and remaining percentage of hydrogen. The right option for the empirical formula of this compound is : [Atomic wt. of C is 12, H is 1]

- (1) CH_2
- (2) CH_3
- (3) CH_4
- (4) CH

84. The maximum temperature that can be achieved in blast furnace is :

- (1) upto 2200 K
- (2) upto 1900 K
- (3) upto 5000 K
- (4) upto 1200 K

85. A particular station of All India Radio, New Delhi, broadcasts on a frequency of 1,368 kHz (kilohertz). The wavelength of the electromagnetic radiation emitted by the transmitter is : [speed of light, $c = 3.0 \times 10^8 \text{ ms}^{-1}$]

- (1) 219.2 m
- (2) 2192 m
- (3) 21.92 cm
- (4) 219.3 m

Section - B (Chemistry)

86. In which one of the following arrangements the given sequence is not strictly according to the properties indicated against it ?

- (1) $\text{H}_2\text{O} < \text{H}_2\text{S} < \text{H}_2\text{Se} < \text{H}_2\text{Te}$: Increasing pK_a values
- (2) $\text{NH}_3 < \text{PH}_3 < \text{AsH}_3 < \text{SbH}_3$: Increasing acidic character
- (3) $\text{CO}_2 < \text{SiO}_2 < \text{SnO}_2 < \text{PbO}_2$: Increasing oxidizing power
- (4) $\text{HF} < \text{HCl} < \text{HBr} < \text{HI}$: Increasing acidic strength

87. The slope of Arrhenius Plot $\left(\ln k \text{ v/s } \frac{1}{T} \right)$ of first order reaction is $-5 \times 10^3 \text{ K}$. The value of E_a of the reaction is. Choose the correct option for your answer.

[Given $R = 8.314 \text{ JK}^{-1} \text{ mol}^{-1}$]

- (1) 83.0 kJ mol^{-1}
- (2) 166 kJ mol^{-1}
- (3) -83 kJ mol^{-1}
- (4) 41.5 kJ mol^{-1}

88. Which of the following molecules is non-polar in nature ?

- (1) CH_2O
- (2) SbCl_5
- (3) NO_2
- (4) POCl_3

89. Match **List - I** with **List - II**.

List - I	List - II
(a) $[\text{Fe}(\text{CN})_6]^{3-}$	(i) 5.92 BM
(b) $[\text{Fe}(\text{H}_2\text{O})_6]^{3+}$	(ii) 0 BM
(c) $[\text{Fe}(\text{CN})_6]^{4-}$	(iii) 4.90 BM
(d) $[\text{Fe}(\text{H}_2\text{O})_6]^{2+}$	(iv) 1.73 BM

Choose the **correct** answer from the options given below.

- (1) (a)-(ii), (b)-(iv), (c)-(iii), (d)-(i)
- (2) (a)-(i), (b)-(iii), (c)-(iv), (d)-(ii)
- (3) (a)-(iv), (b)-(i), (c)-(ii), (d)-(iii)
- (4) (a)-(iv), (b)-(ii), (c)-(i), (d)-(iii)

90. Match List - I with List - II.

- | List - I | List - II |
|--|-----------------------------|
| (a) $2\text{SO}_2(\text{g}) + \text{O}_2(\text{g}) \rightarrow 2\text{SO}_3(\text{g})$ | (i) Acid rain |
| (b) $\text{HOCl}(\text{g}) \xrightarrow{h\nu} \cdot\text{OH} + \cdot\text{Cl}$ | (ii) Smog |
| (c) $\text{CaCO}_3 + \text{H}_2\text{SO}_4 \rightarrow \text{CaSO}_4 + \text{H}_2\text{O} + \text{CO}_2$ | (iii) Ozone depletion |
| (d) $\text{NO}_2(\text{g}) \xrightarrow{h\nu} \text{NO}(\text{g}) + \text{O}(\text{g})$ | (iv) Tropospheric pollution |

Choose the **correct** answer from the options given below.

- (1) (a)-(ii), (b)-(iii), (c)-(iv), (d)-(i)
 (2) (a)-(iv), (b)-(iii), (c)-(i), (d)-(ii)
 (3) (a)-(iii), (b)-(ii), (c)-(iv), (d)-(i)
 (4) (a)-(i), (b)-(ii), (c)-(iii), (d)-(iv)

91. Match List - I with List - II.

- | List - I | List - II |
|--|------------------------------------|
| (a)  $\xrightarrow[\text{Anhyd. AlCl}_3/\text{CuCl}]{\text{CO, HCl}}$ | (i) Hell-Volhard-Zelinsky reaction |
| (b) $\text{R}-\overset{\text{O}}{\parallel}{\text{C}}-\text{CH}_3 + \text{NaOX} \longrightarrow$ | (ii) Gattermann-Koch reaction |
| (c) $\text{R}-\text{CH}_2-\text{OH} + \text{R}'\text{COOH} \xrightarrow{\text{Conc. H}_2\text{SO}_4}$ | (iii) Haloform reaction |
| (d) $\text{R}-\text{CH}_2\text{COOH} \xrightarrow[\text{(ii) H}_2\text{O}]{\text{(i) X}_2/\text{Red P}}$ | (iv) Esterification |

Choose the **correct** answer from the options given below.

- (1) (a)-(iii), (b)-(ii), (c)-(i), (d)-(iv)
 (2) (a)-(i), (b)-(iv), (c)-(iii), (d)-(ii)
 (3) (a)-(ii), (b)-(iii), (c)-(iv), (d)-(i)
 (4) (a)-(iv), (b)-(i), (c)-(ii), (d)-(iii)

92. For irreversible expansion of an ideal gas under isothermal condition, the correct option is :

- (1) $\Delta U \neq 0, \Delta S_{\text{total}} \neq 0$
 (2) $\Delta U = 0, \Delta S_{\text{total}} \neq 0$
 (3) $\Delta U \neq 0, \Delta S_{\text{total}} = 0$
 (4) $\Delta U = 0, \Delta S_{\text{total}} = 0$

93. The correct option for the value of vapour pressure of a solution at 45°C with benzene to octane in molar ratio 3 : 2 is :

[At 45°C vapour pressure of benzene is 280 mm Hg and that of octane is 420 mm Hg. Assume Ideal gas]

- (1) 168 mm of Hg
 (2) 336 mm of Hg
 (3) 350 mm of Hg
 (4) 160 mm of Hg

94. $\text{CH}_3\text{CH}_2\text{COO}^- \text{Na}^+ \xrightarrow[\text{Heat}]{\text{NaOH, + ?}} \text{CH}_3\text{CH}_3 + \text{Na}_2\text{CO}_3$.

Consider the above reaction and identify the missing reagent/chemical.

- (1) Red Phosphorus
 (2) CaO
 (3) DIBAL-H
 (4) B_2H_6

95. The product formed in the following chemical reaction is :

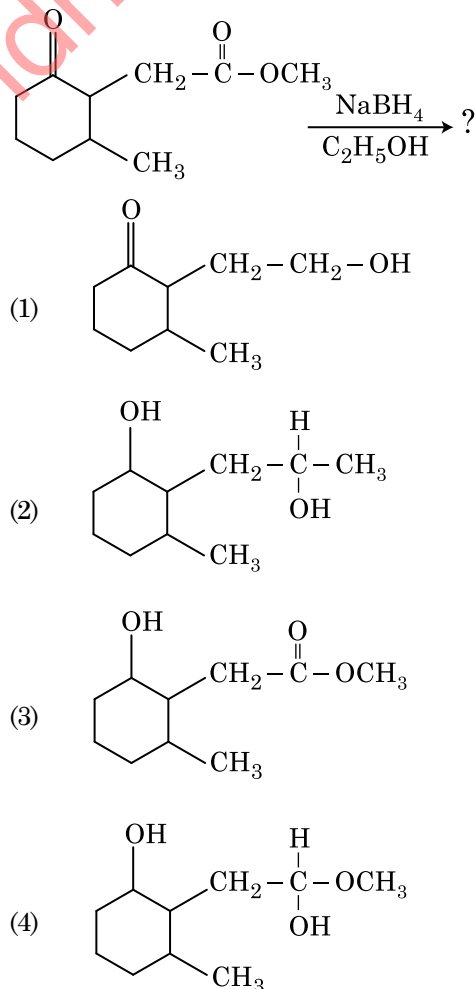

96. The molar conductivity of 0.007 M acetic acid is $20 \text{ S cm}^2 \text{ mol}^{-1}$. What is the dissociation constant of acetic acid? Choose the correct option.

$$\left[\begin{array}{l} \Lambda_{\text{H}^+}^\circ = 350 \text{ S cm}^2 \text{ mol}^{-1} \\ \Lambda_{\text{CH}_3\text{COO}^-}^\circ = 50 \text{ S cm}^2 \text{ mol}^{-1} \end{array} \right]$$

- (1) $2.50 \times 10^{-4} \text{ mol L}^{-1}$
 (2) $1.75 \times 10^{-5} \text{ mol L}^{-1}$
 (3) $2.50 \times 10^{-5} \text{ mol L}^{-1}$
 (4) $1.75 \times 10^{-4} \text{ mol L}^{-1}$
97. Choose the correct option for the total pressure (in atm.) in a mixture of 4 g O_2 and 2 g H_2 confined in a total volume of one litre at 0°C is :

[Given $R = 0.082 \text{ L atm mol}^{-1} \text{ K}^{-1}$, $T = 273 \text{ K}$]

- (1) 2.602
 (2) 25.18
 (3) 26.02
 (4) 2.518
98. From the following pairs of ions which one is not an iso-electronic pair?
- (1) Na^+ , Mg^{2+}
 (2) Mn^{2+} , Fe^{3+}
 (3) Fe^{2+} , Mn^{2+}
 (4) O^{2-} , F^-

99. The reagent 'R' in the given sequence of chemical reaction is :

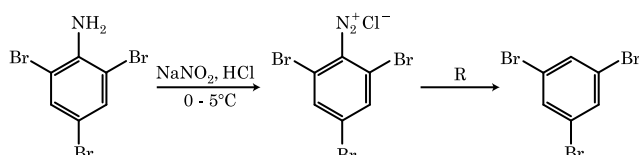

- (1) $\text{CH}_3\text{CH}_2\text{OH}$
 (2) HI
 (3) CuCN/KCN
 (4) H_2O

100. The intermediate compound 'X' in the following chemical reaction is :

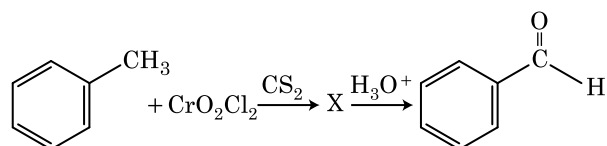

- (1)
- (2)
- (3)
- (4)

Section - A (Biology : Botany)

101. Match List - I with List - II.

List - I		List - II	
(a)	Cohesion	(i)	More attraction in liquid phase
(b)	Adhesion	(ii)	Mutual attraction among water molecules
(c)	Surface tension	(iii)	Water loss in liquid phase
(d)	Guttation	(iv)	Attraction towards polar surfaces

Choose the **correct** answer from the options given below.

- (a) (b) (c) (d)
 (1) (iv) (iii) (ii) (i)
 (2) (iii) (i) (iv) (ii)
 (3) (ii) (i) (iv) (iii)
 (4) (ii) (iv) (i) (iii)

102. When gene targeting involving gene amplification is attempted in an individual's tissue to treat disease, it is known as :

- (1) Gene therapy
 (2) Molecular diagnosis
 (3) Safety testing
 (4) Biopiracy

103. Which of the following stages of meiosis involves division of centromere ?

- (1) Metaphase II
- (2) Anaphase II
- (3) Telophase II
- (4) Metaphase I

104. Which of the following is an **incorrect** statement ?

- (1) Microbodies are present both in plant and animal cells.
- (2) The perinuclear space forms a barrier between the materials present inside the nucleus and that of the cytoplasm.
- (3) Nuclear pores act as passages for proteins and RNA molecules in both directions between nucleus and cytoplasm.
- (4) Mature sieve tube elements possess a conspicuous nucleus and usual cytoplasmic organelles.

105. Amensalism can be represented as :

- (1) Species A (+) ; Species B (+)
- (2) Species A (-) ; Species B (-)
- (3) Species A (+) ; Species B (0)
- (4) Species A (-) ; Species B (0)

106. The amount of nutrients, such as carbon, nitrogen, phosphorus and calcium present in the soil at any given time, is referred as :

- (1) Climax community
- (2) Standing state
- (3) Standing crop
- (4) Climax

107. Which of the following are **not** secondary metabolites in plants ?

- (1) Amino acids, glucose
- (2) Vinblastin, curcumin
- (3) Rubber, gums
- (4) Morphine, codeine

108. In the equation $GPP - R = NPP$

R represents :

- (1) Retardation factor
- (2) Environment factor
- (3) Respiration losses
- (4) Radiant energy

109. Match List - I with List - II.

List - I		List - II	
(a)	Lenticels	(i)	Phellogen
(b)	Cork cambium	(ii)	Suberin deposition
(c)	Secondary cortex	(iii)	Exchange of gases
(d)	Cork	(iv)	Phelloderm

Choose the **correct** answer from the options given below.

- | | (a) | (b) | (c) | (d) |
|-----|-------|-------|-------|-------|
| (1) | (iii) | (i) | (iv) | (ii) |
| (2) | (ii) | (iii) | (iv) | (i) |
| (3) | (iv) | (ii) | (i) | (iii) |
| (4) | (iv) | (i) | (iii) | (ii) |

110. During the purification process for recombinant DNA technology, addition of chilled ethanol precipitates out :

- (1) DNA
- (2) Histones
- (3) Polysaccharides
- (4) RNA

111. Which of the following algae produce Carrageen ?

- (1) Brown algae
- (2) Red algae
- (3) Blue-green algae
- (4) Green algae

112. Plants follow different pathways in response to environment or phases of life to form different kinds of structures. This ability is called :

- (1) Flexibility
- (2) Plasticity
- (3) Maturity
- (4) Elasticity

113. The first stable product of CO_2 fixation in sorghum is :

- (1) Oxaloacetic acid
- (2) Succinic acid
- (3) Phosphoglyceric acid
- (4) Pyruvic acid

114. Which of the following algae contains mannitol as reserve food material ?

- (1) *Gracilaria*
- (2) *Volvox*
- (3) *Ulothrix*
- (4) *Ectocarpus*

115. The plant hormone used to destroy weeds in a field is :

- (1) NAA
- (2) 2, 4-D
- (3) IBA
- (4) IAA

116. When the centromere is situated in the middle of two equal arms of chromosomes, the chromosome is referred as :

- (1) Telocentric
- (2) Sub-metacentric
- (3) Acrocentric
- (4) Metacentric

117. Which of the following plants is monoecious ?

- (1) Chara
- (2) *Marchantia polymorpha*
- (3) *Cycas circinalis*
- (4) *Carica papaya*

118. The site of perception of light in plants during photoperiodism is :

- (1) Stem
- (2) Axillary bud
- (3) Leaf
- (4) Shoot apex

119. Diadelphous stamens are found in :

- (1) Citrus
- (2) Pea
- (3) China rose and citrus
- (4) China rose

120. The production of gametes by the parents, formation of zygotes, the F_1 and F_2 plants, can be understood from a diagram called :

- (1) Punch square
- (2) Punnett square
- (3) Net square
- (4) Bullet square

121. The term used for transfer of pollen grains from anthers of one plant to stigma of a different plant which, during pollination, brings genetically different types of pollen grains to stigma, is :

- (1) Geitonogamy
- (2) Chasmogamy
- (3) Cleistogamy
- (4) Xenogamy

122. Match List - I with List - II.

List - I		List - II	
(a)	Protoplast fusion	(i)	Totipotency
(b)	Plant tissue culture	(ii)	Pomato
(c)	Meristem culture	(iii)	Somaclones
(d)	Micropropagation	(iv)	Virus free plants

Choose the **correct** answer from the options given below.

- | | (a) | (b) | (c) | (d) |
|-----|-------|-------|------|-------|
| (1) | (ii) | (i) | (iv) | (iii) |
| (2) | (iii) | (iv) | (i) | (ii) |
| (3) | (iv) | (iii) | (ii) | (i) |
| (4) | (iii) | (iv) | (ii) | (i) |

123. The factor that leads to Founder effect in a population is :

- (1) Genetic recombination
- (2) Mutation
- (3) Genetic drift
- (4) Natural selection

124. Genera like *Selaginella* and *Salvinia* produce two kinds of spores. Such plants are known as :

- (1) Heterosorus
- (2) Homosporous
- (3) Heterosporous
- (4) Homosorus

125. A typical angiosperm embryo sac at maturity is :

- (1) 7-nucleate and 8-celled
- (2) 7-nucleate and 7-celled
- (3) 8-nucleate and 8-celled
- (4) 8-nucleate and 7-celled

126. Which of the following is **not** an application of PCR (Polymerase Chain Reaction) ?

- (1) Gene amplification
- (2) Purification of isolated protein
- (3) Detection of gene mutation
- (4) Molecular diagnosis

127. In spite of interspecific competition in nature, which mechanism the competing species might have evolved for their survival ?

- (1) Competitive release
- (2) Mutualism
- (3) Predation
- (4) Resource partitioning

128. Gemmae are present in :

- (1) Pteridophytes
- (2) Some Gymnosperms
- (3) Some Liverworts
- (4) Mosses

129. Match List - I with List - II.

List - I		List - II	
(a)	Cells with active cell division capacity	(i)	Vascular tissues
(b)	Tissue having all cells similar in structure and function	(ii)	Meristematic tissue
(c)	Tissue having different types of cells	(iii)	Sclereids
(d)	Dead cells with highly thickened walls and narrow lumen	(iv)	Simple tissue

Select the **correct** answer from the options given below.

- | | (a) | (b) | (c) | (d) |
|-----|-------|-------|-------|-------|
| (1) | (iv) | (iii) | (ii) | (i) |
| (2) | (i) | (ii) | (iii) | (iv) |
| (3) | (iii) | (ii) | (iv) | (i) |
| (4) | (ii) | (iv) | (i) | (iii) |

130. Mutations in plant cells can be induced by :

- (1) Infrared rays
- (2) Gamma rays
- (3) Zeatin
- (4) Kinetin

131. Which of the following is a **correct** sequence of steps in a PCR (Polymerase Chain Reaction) ?

- (1) Denaturation, Extension, Annealing
- (2) Extension, Denaturation, Annealing
- (3) Annealing, Denaturation, Extension
- (4) Denaturation, Annealing, Extension

132. Complete the flow chart on central dogma.

(a) $\text{DNA} \xrightarrow{(b)} \text{mRNA} \xrightarrow{(c)} (d)$

- (1) (a)-Translation; (b)-Replication; (c)-Transcription; (d)-Transduction
- (2) (a)-Replication; (b)-Transcription; (c)-Translation; (d)-Protein
- (3) (a)-Transduction; (b)-Translation; (c)-Replication; (d)-Protein
- (4) (a)-Replication; (b)-Transcription; (c)-Transduction; (d)-Protein

133. Match List - I with List - II.

List - I		List - II	
(a)	Cristae	(i)	Primary constriction in chromosome
(b)	Thylakoids	(ii)	Disc-shaped sacs in Golgi apparatus
(c)	Centromere	(iii)	Infoldings in mitochondria
(d)	Cisternae	(iv)	Flattened membranous sacs in stroma of plastids

Choose the **correct** answer from the options given below.

- | | (a) | (b) | (c) | (d) |
|-----|-------|-------|-------|------|
| (1) | (i) | (iv) | (iii) | (ii) |
| (2) | (iii) | (iv) | (i) | (ii) |
| (3) | (ii) | (iii) | (iv) | (i) |
| (4) | (iv) | (iii) | (ii) | (i) |

134. DNA strands on a gel stained with ethidium bromide when viewed under UV radiation, appear as :

- (1) Bright orange bands
- (2) Dark red bands
- (3) Bright blue bands
- (4) Yellow bands

135. Which of the following statements is **not** correct ?

- (1) Pyramid of biomass in sea is generally upright.
- (2) Pyramid of energy is always upright.
- (3) Pyramid of numbers in a grassland ecosystem is upright.
- (4) Pyramid of biomass in sea is generally inverted.

Section - B (Biology : Botany)

136. Which of the following statements is **incorrect** ?

- (1) In ETC (Electron Transport Chain), one molecule of $\text{NADH} + \text{H}^+$ gives rise to 2 ATP molecules, and one FADH_2 gives rise to 3 ATP molecules.
- (2) ATP is synthesized through complex V.
- (3) Oxidation-reduction reactions produce proton gradient in respiration.
- (4) During aerobic respiration, role of oxygen is limited to the terminal stage.

137. In the exponential growth equation $N_t = N_0 e^{rt}$, e represents :
- (1) The base of exponential logarithms
 - (2) The base of natural logarithms
 - (3) The base of geometric logarithms
 - (4) The base of number logarithms
138. DNA fingerprinting involves identifying differences in some specific regions in DNA sequence, called as :
- (1) Repetitive DNA
 - (2) Single nucleotides
 - (3) Polymorphic DNA
 - (4) Satellite DNA
139. What is the role of RNA polymerase III in the process of transcription in eukaryotes ?
- (1) Transcribes tRNA, 5s rRNA and snRNA
 - (2) Transcribes precursor of mRNA
 - (3) Transcribes only snRNAs
 - (4) Transcribes rRNAs (28S, 18S and 5.8S)
140. Which of the following statements is **incorrect** ?
- (1) Stroma lamellae have PS I only and lack NADP reductase.
 - (2) Grana lamellae have both PS I and PS II.
 - (3) Cyclic photophosphorylation involves both PS I and PS II.
 - (4) Both ATP and $\text{NADPH} + \text{H}^+$ are synthesized during non-cyclic photophosphorylation.
141. Plasmid pBR322 has PstI restriction enzyme site within gene amp^R that confers ampicillin resistance. If this enzyme is used for inserting a gene for β -galactoside production and the recombinant plasmid is inserted in an *E. coli* strain
- (1) the transformed cells will have the ability to resist ampicillin as well as produce β -galactoside.
 - (2) it will lead to lysis of host cell.
 - (3) it will be able to produce a novel protein with dual ability.
 - (4) it will not be able to confer ampicillin resistance to the host cell.

142. Match **Column - I** with **Column - II**.

Column - I	Column - II
(a) $\% \text{♀} \text{K}_{(5)} \text{C}_{1+2+(2)} \text{A}_{(9)+1} \text{G}_1$	(i) Brassicaceae
(b) $\oplus \text{♀} \text{K}_{(5)} \text{C}_{(5)} \text{A}_5 \text{G}_2$	(ii) Liliaceae
(c) $\oplus \text{♀} \text{P}_{(3+3)} \text{A}_{3+3} \text{G}_{(3)}$	(iii) Fabaceae
(d) $\oplus \text{♀} \text{K}_{2+2} \text{C}_4 \text{A}_{2-4} \text{G}_{(2)}$	(iv) Solanaceae

Select the **correct** answer from the options given below.

	(a)	(b)	(c)	(d)
(1)	(i)	(ii)	(iii)	(iv)
(2)	(ii)	(iii)	(iv)	(i)
(3)	(iv)	(ii)	(i)	(iii)
(4)	(iii)	(iv)	(ii)	(i)

143. Select the **correct** pair.

(1)	In dicot leaves, vascular bundles are surrounded by large thick-walled cells	- Conjunctive tissue
(2)	Cells of medullary rays that form part of cambial ring	- Interfascicular cambium
(3)	Loose parenchyma cells rupturing the epidermis and forming a lens-shaped opening in bark	- Spongy parenchyma
(4)	Large colorless empty cells in the epidermis of grass leaves	- Subsidiary cells

144. Identify the **correct** statement.

- (1) RNA polymerase binds with Rho factor to terminate the process of transcription in bacteria.
- (2) The coding strand in a transcription unit is copied to an mRNA.
- (3) Split gene arrangement is characteristic of prokaryotes.
- (4) In capping, methyl guanosine triphosphate is added to the 3' end of hnRNA.

145. Match List - I with List - II.

List - I		List - II	
(a)	S phase	(i)	Proteins are synthesized
(b)	G ₂ phase	(ii)	Inactive phase
(c)	Quiescent stage	(iii)	Interval between mitosis and initiation of DNA replication
(d)	G ₁ phase	(iv)	DNA replication

Choose the **correct** answer from the options given below.

- | | | | | |
|-----|------------|------------|------------|------------|
| | (a) | (b) | (c) | (d) |
| (1) | (iv) | (ii) | (iii) | (i) |
| (2) | (iv) | (i) | (ii) | (iii) |
| (3) | (ii) | (iv) | (iii) | (i) |
| (4) | (iii) | (ii) | (i) | (iv) |

146. Match List - I with List - II.

List - I		List - II	
(a)	Protein	(i)	C = C double bonds
(b)	Unsaturated fatty acid	(ii)	Phosphodiester bonds
(c)	Nucleic acid	(iii)	Glycosidic bonds
(d)	Polysaccharide	(iv)	Peptide bonds

Choose the **correct** answer from the options given below.

- | | | | | |
|-----|------------|------------|------------|------------|
| | (a) | (b) | (c) | (d) |
| (1) | (i) | (iv) | (iii) | (ii) |
| (2) | (ii) | (i) | (iv) | (iii) |
| (3) | (iv) | (iii) | (i) | (ii) |
| (4) | (iv) | (i) | (ii) | (iii) |

147. Match Column - I with Column - II.

Column - I		Column - II	
(a)	<i>Nitrococcus</i>	(i)	Denitrification
(b)	<i>Rhizobium</i>	(ii)	Conversion of ammonia to nitrite
(c)	<i>Thiobacillus</i>	(iii)	Conversion of nitrite to nitrate
(d)	<i>Nitrobacter</i>	(iv)	Conversion of atmospheric nitrogen to ammonia

Choose the **correct** answer from options given below.

- | | | | | |
|-----|------------|------------|------------|------------|
| | (a) | (b) | (c) | (d) |
| (1) | (i) | (ii) | (iii) | (iv) |
| (2) | (iii) | (i) | (iv) | (ii) |
| (3) | (iv) | (iii) | (ii) | (i) |
| (4) | (ii) | (iv) | (i) | (iii) |

148. Which of the following statements is **correct** ?

- (1) Fusion of protoplasts between two motile on non-motile gametes is called plasmogamy.
- (2) Organisms that depend on living plants are called saprophytes.
- (3) Some of the organisms can fix atmospheric nitrogen in specialized cells called sheath cells.
- (4) Fusion of two cells is called Karyogamy.

149. Now a days it is possible to detect the mutated gene causing cancer by allowing radioactive probe to hybridise its complimentary DNA in a clone of cells, followed by its detection using autoradiography because :

- (1) mutated gene completely and clearly appears on a photographic film.
- (2) mutated gene does not appear on a photographic film as the probe has no complementarity with it.
- (3) mutated gene does not appear on photographic film as the probe has complementarity with it.
- (4) mutated gene partially appears on a photographic film.

150. In some members of which of the following pairs of families, pollen grains retain their viability for months after release ?

- (1) Poaceae ; Leguminosae
- (2) Poaceae ; Solanaceae
- (3) Rosaceae ; Leguminosae
- (4) Poaceae ; Rosaceae

Section - A (Biology : Zoology)

151. Which of the following is **not** an objective of Biofortification in crops ?

- (1) Improve resistance to diseases
- (2) Improve vitamin content
- (3) Improve micronutrient and mineral content
- (4) Improve protein content

152. If Adenine makes 30% of the DNA molecule, what will be the percentage of Thymine, Guanine and Cytosine in it ?

- (1) T : 20 ; G : 20 ; C : 30
- (2) T : 30 ; G : 20 ; C : 20
- (3) T : 20 ; G : 25 ; C : 25
- (4) T : 20 ; G : 30 ; C : 20

153. The fruit fly has 8 chromosomes ($2n$) in each cell. During interphase of Mitosis if the number of chromosomes at G_1 phase is 8, what would be the number of chromosomes after S phase ?

- (1) 16
- (2) 4
- (3) 32
- (4) 8

154. Which one of the following is an example of Hormone releasing IUD ?

- (1) LNG 20
- (2) Cu 7
- (3) Multiload 375
- (4) CuT

155. Succus entericus is referred to as :

- (1) Intestinal juice
- (2) Gastric juice
- (3) Chyme
- (4) Pancreatic juice

156. A specific recognition sequence identified by endonucleases to make cuts at specific positions within the DNA is :

- (1) Okazaki sequences
- (2) Palindromic Nucleotide sequences
- (3) Poly(A) tail sequences
- (4) Degenerate primer sequence

157. Read the following statements.

- (a) Metagenesis is observed in Helminths.
- (b) Echinoderms are triploblastic and coelomate animals.
- (c) Round worms have organ-system level of body organization.
- (d) Comb plates present in ctenophores help in digestion.
- (e) Water vascular system is characteristic of Echinoderms.

Choose the **correct** answer from the options given below.

- (1) (a), (b) and (c) are correct
- (2) (a), (d) and (e) are correct
- (3) (b), (c) and (e) are correct
- (4) (c), (d) and (e) are correct

158. With regard to insulin choose correct options.

- (a) C-peptide is not present in mature insulin.
- (b) The insulin produced by rDNA technology has C-peptide.
- (c) The pro-insulin has C-peptide.
- (d) A-peptide and B-peptide of insulin are interconnected by disulphide bridges.

Choose the **correct** answer from the options given below.

- (1) (b) and (c) only
- (2) (a), (c) and (d) only
- (3) (a) and (d) only
- (4) (b) and (d) only

159. Match List - I with List - II.

List - I		List - II	
(a)	Metamerism	(i)	Coelenterata
(b)	Canal system	(ii)	Ctenophora
(c)	Comb plates	(iii)	Annelida
(d)	Cnidoblasts	(iv)	Porifera

Choose the **correct** answer from the options given below.

- | | (a) | (b) | (c) | (d) |
|-----|-------|-------|------|-------|
| (1) | (iii) | (iv) | (i) | (ii) |
| (2) | (iii) | (iv) | (ii) | (i) |
| (3) | (iv) | (i) | (ii) | (iii) |
| (4) | (iv) | (iii) | (i) | (ii) |

160. Dobson units are used to measure thickness of :

- (1) Stratosphere
- (2) Ozone
- (3) Troposphere
- (4) CFCs

161. Which one of the following organisms bears hollow and pneumatic long bones ?

- (1) *Hemidactylus*
- (2) *Macropus*
- (3) *Ornithorhynchus*
- (4) *Neophron*

162. Which of the following RNAs is not required for the synthesis of protein ?

- (1) tRNA
- (2) rRNA
- (3) siRNA
- (4) mRNA

163. Sphincter of oddi is present at :
- (1) Junction of hepato-pancreatic duct and duodenum
 - (2) Gastro-oesophageal junction
 - (3) Junction of jejunum and duodenum
 - (4) Ileo-caecal junction
164. Which stage of meiotic prophase shows terminalisation of chiasmata as its distinctive feature ?
- (1) Zygotene
 - (2) Diakinesis
 - (3) Pachytene
 - (4) Leptotene
165. For effective treatment of the disease, early diagnosis and understanding its pathophysiology is very important. Which of the following molecular diagnostic techniques is very useful for early detection ?
- (1) Southern Blotting Technique
 - (2) ELISA Technique
 - (3) Hybridization Technique
 - (4) Western Blotting Technique
166. Which of the following characteristics is **incorrect** with respect to cockroach ?
- (1) Hypopharynx lies within the cavity enclosed by the mouth parts.
 - (2) In females, 7th-9th sterna together form a genital pouch.
 - (3) 10th abdominal segment in both sexes, bears a pair of anal cerci.
 - (4) A ring of gastric caeca is present at the junction of midgut and hind gut.
167. The partial pressures (in mm Hg) of oxygen (O₂) and carbon dioxide (CO₂) at alveoli (the site of diffusion) are :
- (1) pO₂ = 40 and pCO₂ = 45
 - (2) pO₂ = 95 and pCO₂ = 40
 - (3) pO₂ = 159 and pCO₂ = 0.3
 - (4) pO₂ = 104 and pCO₂ = 40
168. Identify the **incorrect** pair.
- (1) Toxin - Abrin
 - (2) Lectins - Concanavalin A
 - (3) Drugs - Ricin
 - (4) Alkaloids - Codeine
169. Which is the "Only enzyme" that has "Capability" to catalyse Initiation, Elongation and Termination in the process of transcription in prokaryotes ?
- (1) DNA dependent RNA polymerase
 - (2) DNA Ligase
 - (3) DNase
 - (4) DNA dependent DNA polymerase

170. Select the favourable conditions required for the formation of oxyhaemoglobin at the alveoli.
- (1) Low pO₂, high pCO₂, more H⁺, higher temperature
 - (2) High pO₂, high pCO₂, less H⁺, higher temperature
 - (3) Low pO₂, low pCO₂, more H⁺, higher temperature
 - (4) High pO₂, low pCO₂, less H⁺, lower temperature
171. Persons with 'AB' blood group are called as "Universal recipients". This is due to :
- (1) Absence of antigens A and B in plasma
 - (2) Presence of antibodies, anti-A and anti-B, on RBCs
 - (3) Absence of antibodies, anti-A and anti-B, in plasma
 - (4) Absence of antigens A and B on the surface of RBCs

172. Match the following :

List - I		List - II	
(a)	<i>Physalia</i>	(i)	Pearl oyster
(b)	<i>Limulus</i>	(ii)	Portuguese Man of War
(c)	<i>Ancylostoma</i>	(iii)	Living fossil
(d)	<i>Pinctada</i>	(iv)	Hookworm

Choose the **correct** answer from the options given below.

- | | | | | |
|--|------------|------------|------------|------------|
| | (a) | (b) | (c) | (d) |
|--|------------|------------|------------|------------|
- (1) (iv) (i) (iii) (ii)
 - (2) (ii) (iii) (iv) (i)
 - (3) (i) (iv) (iii) (ii)
 - (4) (ii) (iii) (i) (iv)
173. In a cross between a male and female, both heterozygous for sickle cell anaemia gene, what percentage of the progeny will be diseased ?
- (1) 75%
 - (2) 25%
 - (3) 100%
 - (4) 50%
174. Venereal diseases can spread through :
- (a) Using sterile needles
 - (b) Transfusion of blood from infected person
 - (c) Infected mother to foetus
 - (d) Kissing
 - (e) Inheritance
- Choose the **correct** answer from the options given below.
- (1) (b), (c) and (d) only
 - (2) (b) and (c) only
 - (3) (a) and (c) only
 - (4) (a), (b) and (c) only

175. Chronic auto immune disorder affecting neuro muscular junction leading to fatigue, weakening and paralysis of skeletal muscle is called as :

- (1) Muscular dystrophy
- (2) Myasthenia gravis
- (3) Gout
- (4) Arthritis

176. Which one of the following belongs to the family Muscidae ?

- (1) Grasshopper
- (2) Cockroach
- (3) House fly
- (4) Fire fly

177. Match List - I with List - II.

List - I		List - II	
(a)	Vaults	(i)	Entry of sperm through Cervix is blocked
(b)	IUDs	(ii)	Removal of Vas deferens
(c)	Vasectomy	(iii)	Phagocytosis of sperms within the Uterus
(d)	Tubectomy	(iv)	Removal of fallopian tube

Choose the **correct** answer from the options given below.

- | | (a) | (b) | (c) | (d) |
|-----|-------|-------|-------|-------|
| (1) | (i) | (iii) | (ii) | (iv) |
| (2) | (ii) | (iv) | (iii) | (i) |
| (3) | (iii) | (i) | (iv) | (ii) |
| (4) | (iv) | (ii) | (i) | (iii) |

178. During the process of gene amplification using PCR, if very high temperature is not maintained in the beginning, then which of the following steps of PCR will be affected first ?

- (1) Extension
- (2) Denaturation
- (3) Ligation
- (4) Annealing

179. Which enzyme is responsible for the conversion of inactive fibrinogens to fibrins ?

- (1) Renin
- (2) Epinephrine
- (3) Thrombokinas
- (4) Thrombin

180. The organelles that are included in the endomembrane system are :

- (1) Endoplasmic reticulum, Golgi complex, Lysosomes and Vacuoles
- (2) Golgi complex, Mitochondria, Ribosomes and Lysosomes
- (3) Golgi complex, Endoplasmic reticulum, Mitochondria and Lysosomes
- (4) Endoplasmic reticulum, Mitochondria, Ribosomes and Lysosomes

181. Match List - I with List - II.

List - I		List - II	
(a)	<i>Aspergillus niger</i>	(i)	Acetic Acid
(b)	<i>Acetobacter aceti</i>	(ii)	Lactic Acid
(c)	<i>Clostridium butylicum</i>	(iii)	Citric Acid
(d)	<i>Lactobacillus</i>	(iv)	Butyric Acid

Choose the **correct** answer from the options given below.

- | | (a) | (b) | (c) | (d) |
|-----|-------|-------|-------|-------|
| (1) | (i) | (ii) | (iii) | (iv) |
| (2) | (ii) | (iii) | (i) | (iv) |
| (3) | (iv) | (ii) | (i) | (iii) |
| (4) | (iii) | (i) | (iv) | (ii) |

182. Receptors for sperm binding in mammals are present on :

- (1) Vitelline membrane
- (2) Perivitelline space
- (3) Zona pellucida
- (4) Corona radiata

183. Which of the following statements wrongly represents the nature of smooth muscle ?

- (1) They are involuntary muscles
- (2) Communication among the cells is performed by intercalated discs
- (3) These muscles are present in the wall of blood vessels
- (4) These muscle have no striations

184. The centriole undergoes duplication during :

- (1) Prophase
- (2) Metaphase
- (3) G₂ phase
- (4) S-phase

185. Erythropoietin hormone which stimulates R.B.C. formation is produced by :

- (1) The cells of rostral adenohypophysis
- (2) The cells of bone marrow
- (3) Juxtaglomerular cells of the kidney
- (4) Alpha cells of pancreas

Section - B (Biology : Zoology)

186. Which of these is not an important component of initiation of parturition in humans ?

- (1) Synthesis of prostaglandins
- (2) Release of Oxytocin
- (3) Release of Prolactin
- (4) Increase in estrogen and progesterone ratio

187. Following are the statements with reference to 'lipids'.

- (a) Lipids having only single bonds are called unsaturated fatty acids.
- (b) Lecithin is a phospholipid.
- (c) Trihydroxy propane is glycerol.
- (d) Palmitic acid has 20 carbon atoms including carboxyl carbon.
- (e) Arachidonic acid has 16 carbon atoms.

Choose the **correct** answer from the options given below.

- (1) (c) and (d) only
- (2) (b) and (c) only
- (3) (b) and (e) only
- (4) (a) and (b) only

188. Match List - I with List - II.

List - I		List - II	
(a)	Filariasis	(i)	<i>Haemophilus influenzae</i>
(b)	Amoebiasis	(ii)	<i>Trichophyton</i>
(c)	Pneumonia	(iii)	<i>Wuchereria bancrofti</i>
(d)	Ringworm	(iv)	<i>Entamoeba histolytica</i>

Choose the **correct** answer from the options given below.

- | | | | | |
|-----|------------|------------|------------|------------|
| | (a) | (b) | (c) | (d) |
| (1) | (iii) | (iv) | (i) | (ii) |
| (2) | (i) | (ii) | (iv) | (iii) |
| (3) | (ii) | (iii) | (i) | (iv) |
| (4) | (iv) | (i) | (iii) | (ii) |

189. The Adenosine deaminase deficiency results into :

- (1) Parkinson's disease
- (2) Digestive disorder
- (3) Addison's disease
- (4) Dysfunction of Immune system

190. **Statement I :**

The codon 'AUG' codes for methionine and phenylalanine.

Statement II :

'AAA' and 'AAG' both codons code for the amino acid lysine.

In the light of the above statements, choose the **correct** answer from the options given below.

- (1) Both **Statement I** and **Statement II** are false
- (2) **Statement I** is correct but **Statement II** is false
- (3) **Statement I** is incorrect but **Statement II** is true
- (4) Both **Statement I** and **Statement II** are true

191. Match List - I with List - II.

List - I		List - II	
(a)	Adaptive radiation	(i)	Selection of resistant varieties due to excessive use of herbicides and pesticides
(b)	Convergent evolution	(ii)	Bones of forelimbs in Man and Whale
(c)	Divergent evolution	(iii)	Wings of Butterfly and Bird
(d)	Evolution by anthropogenic action	(iv)	Darwin Finches

Choose the **correct** answer from the options given below.

- | | | | | |
|-----|------------|------------|------------|------------|
| | (a) | (b) | (c) | (d) |
| (1) | (iii) | (ii) | (i) | (iv) |
| (2) | (ii) | (i) | (iv) | (iii) |
| (3) | (i) | (iv) | (iii) | (ii) |
| (4) | (iv) | (iii) | (ii) | (i) |

192. During muscular contraction which of the following events occur ?

- (a) 'H' zone disappears
- (b) 'A' band widens
- (c) 'I' band reduces in width
- (d) Myosine hydrolyzes ATP, releasing the ADP and Pi
- (e) Z-lines attached to actins are pulled inwards

Choose the **correct** answer from the options given below.

- (1) (a), (b), (c), (d) only
- (2) (b), (c), (d), (e) only
- (3) (b), (d), (e), (a) only
- (4) (a), (c), (d), (e) only

193. Which of the following secretes the hormone, relaxin, during the later phase of pregnancy ?

- (1) Corpus luteum
- (2) Foetus
- (3) Uterus
- (4) Graafian follicle

194. Assertion (A) :

A person goes to high altitude and experiences 'altitude sickness' with symptoms like breathing difficulty and heart palpitations.

Reason (R) :

Due to low atmospheric pressure at high altitude, the body does not get sufficient oxygen.

In the light of the above statements, choose the **correct** answer from the options given below.

- (1) Both (A) and (R) are true but (R) is not the correct explanation of (A)
- (2) (A) is true but (R) is false
- (3) (A) is false but (R) is true
- (4) Both (A) and (R) are true and (R) is the correct explanation of (A)

195. Following are the statements about prostomium of earthworm.

- (a) It serves as a covering for mouth.
- (b) It helps to open cracks in the soil into which it can crawl.
- (c) It is one of the sensory structures.
- (d) It is the first body segment.

Choose the **correct** answer from the options given below.

- (1) (a), (b) and (d) are correct
- (2) (a), (b), (c) and (d) are correct
- (3) (b) and (c) are correct
- (4) (a), (b) and (c) are correct

196. Match List - I with List - II.

List - I		List - II	
(a)	Scapula	(i)	Cartilaginous joints
(b)	Cranium	(ii)	Flat bone
(c)	Sternum	(iii)	Fibrous joints
(d)	Vertebral column	(iv)	Triangular flat bone

Choose the **correct** answer from the options given below.

- | | (a) | (b) | (c) | (d) |
|-----|------|-------|-------|------|
| (1) | (ii) | (iii) | (iv) | (i) |
| (2) | (iv) | (ii) | (iii) | (i) |
| (3) | (iv) | (iii) | (ii) | (i) |
| (4) | (i) | (iii) | (ii) | (iv) |

197. Match List - I with List - II.

List - I		List - II	
(a)	Allen's Rule	(i)	Kangaroo rat
(b)	Physiological adaptation	(ii)	Desert lizard
(c)	Behavioural adaptation	(iii)	Marine fish at depth
(d)	Biochemical adaptation	(iv)	Polar seal

Choose the **correct** answer from the options given below.

- | | (a) | (b) | (c) | (d) |
|-----|------|-------|-------|-------|
| (1) | (iv) | (i) | (iii) | (ii) |
| (2) | (iv) | (i) | (ii) | (iii) |
| (3) | (iv) | (iii) | (ii) | (i) |
| (4) | (iv) | (ii) | (iii) | (i) |

198. Which one of the following statements about Histones is **wrong** ?

- (1) The pH of histones is slightly acidic.
- (2) Histones are rich in amino acids - Lysine and Arginine.
- (3) Histones carry positive charge in the side chain.
- (4) Histones are organized to form a unit of 8 molecules.

199. Identify the types of cell junctions that help to stop the leakage of the substances across a tissue and facilitation of communication with neighbouring cells via rapid transfer of ions and molecules.

- (1) Tight junctions and Gap junctions, respectively.
- (2) Adhering junctions and Tight junctions, respectively.
- (3) Adhering junctions and Gap junctions, respectively.
- (4) Gap junctions and Adhering junctions, respectively.

200. Which of the following is **not** a step in Multiple Ovulation Embryo Transfer Technology (MOET) ?

- (1) Cow yields about 6-8 eggs at a time
- (2) Cow is fertilized by artificial insemination
- (3) Fertilized eggs are transferred to surrogate mothers at 8-32 cell stage
- (4) Cow is administered hormone having LH like activity for super ovulation

Space For Rough Work

downloaded from
StudentSuvidha.com

Space For Rough Work

downloaded from
StudentSuvidha.com

Space For Rough Work

downloaded from
StudentSuvidha.com